

Uponor

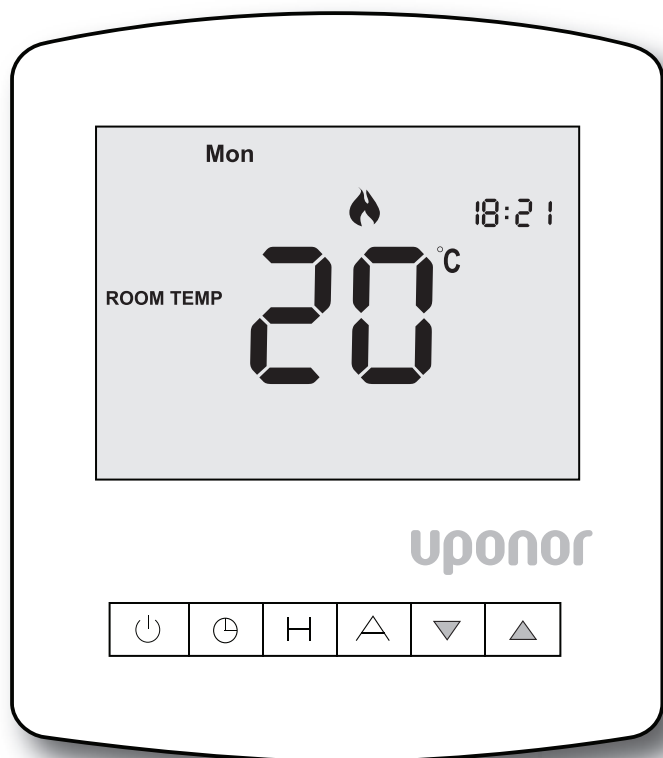

Uponor Comfort-E Thermostat Dig. Prog Set T-86

EN INSTALLATION AND OPERATION
MANUAL

Contents

1	Copyright and disclaimer	3
2	Preface	4
2.1	Safety instructions	4
2.2	Correct disposal of this product	4
3	Introduction.....	5
4	Installation	6
4.1	Installation Procedure.....	6
5	Operation.....	7
5.1	LCD Display	7
5.2	Turn Thermostat On/Off	7
5.3	Set the Clock	7
5.4	Temperature Display	8
5.5	Set the Comfort Levels	8
5.6	Lock the Thermostat.....	9
5.7	Temperature Control.....	10
5.8	Temperature Hold.....	10
5.9	Holiday Mode.....	10
5.10	Frost Protection.....	10
5.11	Optional Features	11
6	Troubleshooting	13
6.1	Error Codes.....	13
6.2	Re-calibrate the Thermostat	13
6.3	Factory Reset.....	13
7	Technical data.....	14
7.1	Technical specification.....	14
7.2	Dimensions.....	14
7.3	Wiring Diagram.....	15

1 Copyright and disclaimer

Uponor has prepared this installation and operation manual and all the content included solely for information purposes. The contents of the manual (including graphics, logos, icons, text, and images) are copyrighted and protected by worldwide copyright laws and treaty provisions. You agree to comply with all copyright laws worldwide in your use of the manual. Modification or use of any of the contents of the manual for any other purpose is a violation of Uponor's copyright, trademark and other proprietary rights.

The presumption for the manual is that the safety measures have been fully complied with and, further, that Uponor Comfort-E Thermostat Dig. Prog Set T-86, including any components that are part of such system, covered by the manual:

- is selected, planned and installed and put into operation by a licensed and competent planner and installer in compliance with current (at the time of installation) installation instructions provided by Uponor as well as in compliance with all applicable building and plumbing codes and other requirements and guidelines;
- has not been (temporarily or continuously) exposed to temperatures, pressure and/or voltages that exceed the limits printed on the products or stated in any instructions supplied by Uponor;
- remain in its originally installed location and is not repaired, replaced or interfered with, without prior written consent of Uponor;
- is connected to potable water supplies or compatible plumbing, heating and/or cooling products approved or specified by Uponor;
- is not connected to or used with non-Uponor products, parts or components except for those approved or specified by Uponor; and
- does not show evidence of tampering, mishandling, insufficient maintenance, improper storage, neglect or accidental damage before installation and being put into operation.

While Uponor has made efforts to ensure that the manual is accurate, Uponor does not guarantee or warrant the accuracy of the information contained herein. Uponor reserves the right to modify the specifications and features described herein, or discontinue manufacture of Uponor Comfort-E Thermostat Dig. Prog Set T-86 described at any time without prior notice or obligation. The manual is provided "as is" without warranties of any kind, either expressed or implied. The information should be independently verified before using it in any manner.

To the fullest extent permissible, Uponor disclaims all warranties, expressed or implied, including, but not limited to, the implied warranties of merchantability, fitness for particular purpose and non-infringement.

This disclaimer applies to, but is not limited to, the accuracy, reliability or correctness of the manual.

Under no circumstances shall Uponor be liable for any indirect, special, incidental or consequential damages or loss that result from the use of or the inability to use the materials or information in the manual, or any claim attributable to errors, omission or other inaccuracies in the manual, even if Uponor has been advised of the possibility of such damages.

This disclaimer and any provisions in the manual do not limit any statutory rights of consumers.

2 Preface

This installation and operation manual describes how to install and operate the components of the system.

2.1 Safety instructions

Safety measures

Conform to the following measures when installing and operating any Uponor equipment:

- Read and follow the instructions in the installation and operation manual.
- Installation must be performed by a competent person in accordance with local regulations.
- It is prohibited to make changes or modifications not specified in this manual.
- All power supply must be switched off before starting any wiring work.
- Do not use water to clean Uponor components.
- Do not expose the Uponor components to flammable vapours or gases.

We cannot accept any responsibility for damage or breakdown that can result from ignoring these instructions.

Power



WARNING!

The Uponor system uses 50 Hz, 230 V AC power. In case of emergency, immediately disconnect the power.

Technical constraints



CAUTION!

To avoid interference, keep installation/data cables away from power cables of more than 50 V.

2.2 Correct disposal of this product

(Waste Electrical and Electronic Equipment)



NOTE!

Applicable in the European Union and other European countries with separate collection systems



This marking shown on the product or its literature indicates that it should not be disposed with other household waste at the end of its working life. To prevent possible harm to the environment or human health from uncontrolled waste disposal, please separate this from other types of wastes and recycle it responsibly to promote the sustainable reuse of material resources.

Household users should contact either the retailer where they purchased this product, or their local government office, for details of where and how they can take this item for environmentally safe recycling.

Business users should contact their supplier and check the terms and conditions of the purchase contract. This product should not be mixed with other commercial wastes of disposal.

3 Introduction

A programmable room thermostat is both a programmer and a room thermostat.

A programmer allows you to set “On” and “Off” periods to suit your own lifestyle. A room thermostat works by sensing the air temperature, switching on the heating when the air temperature falls below the thermostat setting, and switching it off once this set temperature has been reached.

So a programmable room thermostat lets you choose what times you want the heating to be on, and what temperature it should reach while it is on. It will allow you to select different temperatures in your home at different times of the day (and days of the week) to meet your particular needs and preferences.

Setting a programmable room thermostat to a higher temperature will not make the room heat up any faster. How quickly the room heats up depends on the design and size of the floor heating system.

Similarly reducing the temperature setting does not affect how quickly the room cools down. Setting a programmable room thermostat to a lower temperature will result in the room being controlled at a lower temperature, and saves energy.

The way to set and use your programmable room thermostat is to find the lowest temperature settings that you are comfortable with at the different times you have chosen, and then leave it alone to do its job.

The best way to do this is to set the room thermostat to a low temperature – say 18°C, and then turn it up by 1°C each day until you are comfortable with the temperature. You won’t have to adjust the thermostat further. Any adjustment above this setting will waste energy and cost you more money.

You are able to temporarily adjust the heating program by overriding or using the temperature hold feature.

Programmable room thermostats need a free flow of air to sense the temperature, so they must not be covered by curtains or blocked by furniture. Nearby electric fires, televisions, wall or table lamps may also prevent the thermostat from working properly.

4 Installation

4.1 Installation Procedure

 **Do**
Mount the thermostat at eye level.

 **Don't**
Do not install near to a direct heat source as this will affect functionality. Do not push hard on the LCD screen as this may cause irreparable damage.

This thermostat is designed to be flush mounted and requires a back box of 35mm (minimum depth) to be sunk into the wall prior to installation.

To install the thermostat, follow these steps:

1. Separate the front half of the thermostat from the back plate by placing a small flat head terminal driver into the slots on the bottom face of the thermostat.

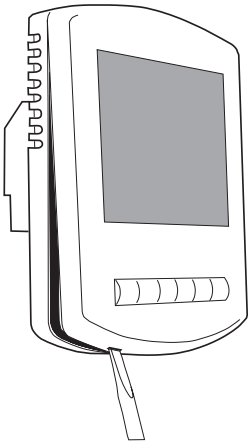

2. Place the thermostat front somewhere safe.

3. Connect the thermostat.

For more information, see section "7.3 Wiring Diagram" on page 18.

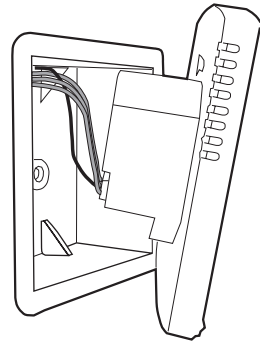

4. Screw the thermostat back plate into the back box.

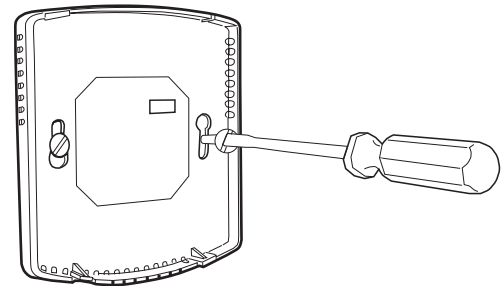

5. Clip the front of the thermostat back onto the thermostat back plate.

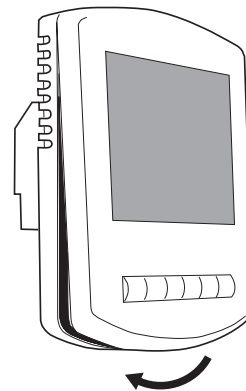

5 Operation

5.1 LCD Display

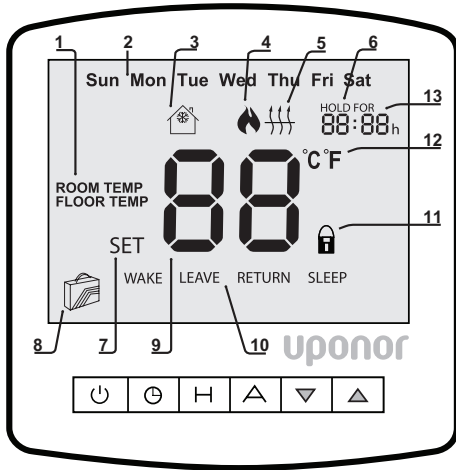

Pos	Description
1	Room/Floor Temperature - Indicates the current temperature sensor mode.
2	Day Indicator - Displays the current day.
3	Frost Icon - Displayed when the thermostat is in frost protection mode.
4	Flame Icon - Displayed when the thermostat is calling for heat, the flame icon will flash when the optimum start function is in operation.
5	Floor Temperature Limit Icon - Displayed when the floor sensor probe has reached the temperature limit set on feature 09.
6	Temperature Hold - When a Temp Hold is active, HOLD FOR and the remaining time period is displayed.
7	Set - Indicates when changes are being made to programs or temperature set points.
8	Holiday Indicator - Displayed when the thermostat is in holiday mode.

Pos	Description
9	Current Temperature - Indicates the current sensor temperature.
10	Program Cycle Indicator - Displayed during programming only to show which period is being altered.
11	Keypad Lock Indicator - Displayed when the keypad is locked.
12	Units of Temperature - Degrees Celsius or Fahrenheit.
13	Clock - Digital clock display in 24h format.

5.2 Turn Thermostat On/Off

To turn ON the thermostat:

1. Press once.

The heating is indicated ON when the flame icon is displayed.

When the flame icon is absent, there is no requirement for heating to achieve the set temperature but the thermostat remains active.

To turn OFF the thermostat:

1. Press and hold .

The display and heating output will be turned OFF completely. For more information, see Feature 03 in section "5.11 Optional Features" on page 12.

5.3 Set the Clock

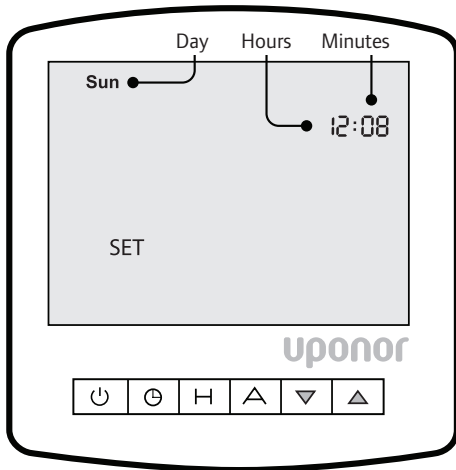

To set the clock, follow these steps.

1. With the thermostat turned ON, press the **⏻** twice.
2. Use **∇Δ** to set the hours.
3. Press **H** to confirm settings.
4. Use **∇Δ** to set the minutes.
5. Press **H** to confirm settings.
6. Use **∇Δ** to set the day of the week.
7. Press **A** to confirm settings and return to main display.

5.4 Temperature Display

This thermostat can show room and floor temperatures, depending on if it is set up to use an air sensor, floor sensor or both. The display will clearly show which sensor is being controlled.

When the thermostat is set to use both sensors, the room temperature will be displayed.

To view the floor temperature, follow this step:

1. Press and hold **A** until Floor Temp is displayed on screen.

Floor temperature will display for 5 seconds.

ROOM TEMPERATURE:

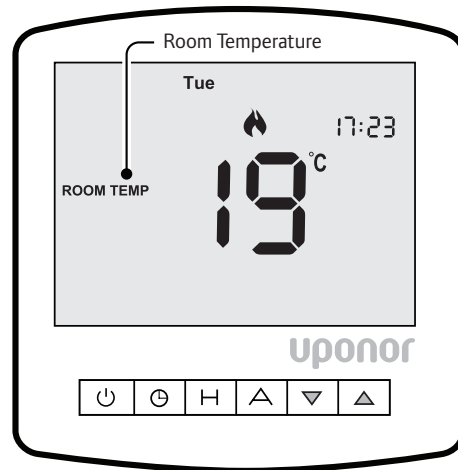

FLOOR TEMPERATURE:

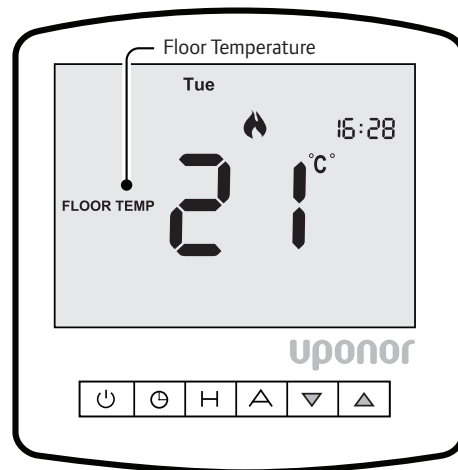

Note: Built in air sensor only **MUST NOT** be used to control electric underfloor heating. Floor sensor only or built in air & floor sensor together must be used.

5.5 Set the Comfort Levels

The thermostat lets you program a schedule for your home that controls different temperatures at different times of the day (and days of the week).

The schedule divides the day in four comfort levels. The levels are defined by the time you wake up, leave the house, return to the house and go to sleep.

Three programming mode options exist, which offers different options for programming the schedule:

- **Non-Programmable** – Basic up/down override temperature control.
- **5/2 Day Programming** – 4 comfort levels for the weekdays and 4 for the weekend.
- **7 Day Programming** – 4 comfort levels for each day.
- **24h Programming** – 4 comfort levels for 24 hours.

See section “5.11 Optional Features” on page 12 for information on how to activate (Feature 11), and change programming modes (Feature 10).

To schedule time and temperature, follow these steps.

(The instruction below is for 5/2 Day Programming. It starts by programming the schedule for weekdays, followed by weekends.)

1. Set the **wake** time and temperature.
 - A. Press **⏻** once.
 - B. Use **∇Δ** to adjust wake time.
 - C. Use **H** to accept.
 - D. Use **∇Δ** to adjust temperature.
 - E. Press **H** to accept.

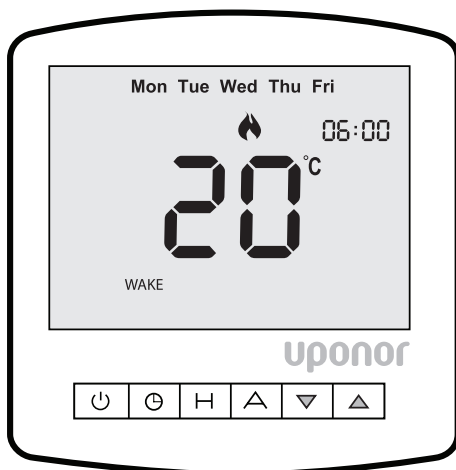

2. Set the **leave** time and temperature.
 - A. Press **∇Δ** to adjust leave time.
 - B. Press **H** to accept.
 - C. Use **∇Δ** to adjust temperature.
 - D. Press **H** to accept.

Note: Uponor recommend reducing the setpoint temperature by 4 °C.

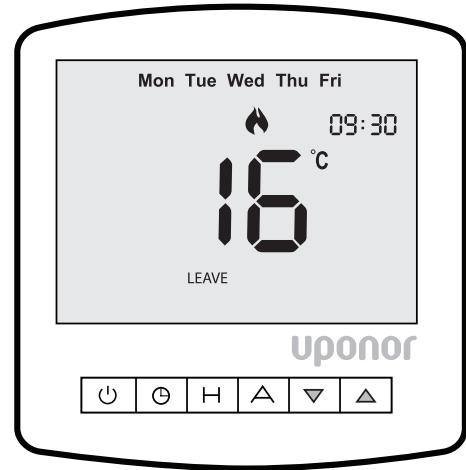

3. Set the **return** time and temperature.
 - A. Use **∇Δ** to adjust return time.
 - B. Press **H** to accept.
 - C. Use **∇Δ** to adjust temperature.
 - D. Press **H** to accept.

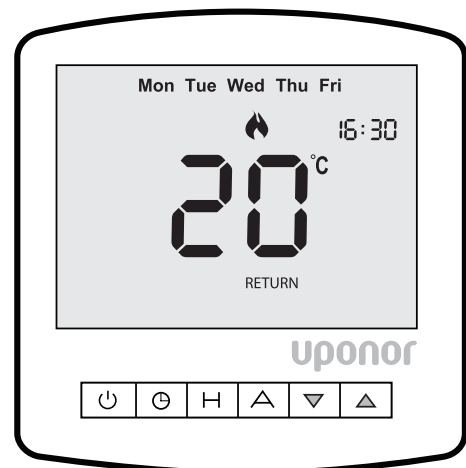

4. Set the **sleep** time and temperature.
 - A. Use $\nabla\Delta$ to adjust sleep time.
 - B. Press **H** to accept.
 - C. Use $\nabla\Delta$ to adjust temperature.
 - D. Press **H** to accept.

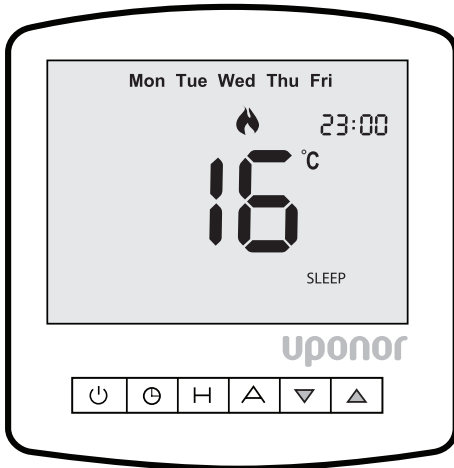

5. Set the weekend times and temperatures (wake, leave, return, and sleep):
 - A. Repeat step 1 to 4 for the weekend schedule.
 - B. Press **A** at end of sequence to store and exit.

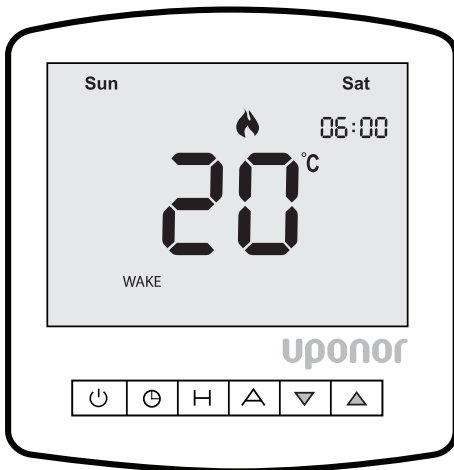

5.6 Lock the Thermostat

The thermostat has a keypad lock facility.

To activate the lock, follow this step.

1. Press and hold **A** and ∇ together for 10 seconds.

You will see  appear on screen.

To unlock, repeat the step above until the lock symbol disappears.

Note: The keypad lock indicator is only displayed when the lock is active.

5.7 Temperature Control

To adjust the set temperature, follow these steps:

1. Adjust the set temperature with $\nabla\Delta$.

When you press either key, you will see the word SET and the desired temperature will be displayed on screen.

2. Press **A** to confirm settings and return to the main display.

Note:

- In programmable mode, this new temperature is maintained only until the next programmed comfort level.
- In non-programmable mode, this temperature will be constantly maintained.

5.8 Temperature Hold

The temperature hold function allows you to manually override the current operating program and set a different temperature for a desired period.

To set temperature hold, follow these steps:

1. Press **H** to commence temperature hold.
2. Use $\nabla\Delta$ to enter the required Hold time, in intervals of 30 minutes.
3. Press **H** to confirm settings.
4. Use $\nabla\Delta$ to enter the required Hold temperature.
5. Press **A** to confirm settings and return to main display.

You will see the HOLD FOR indication is displayed on screen. The time will countdown the set duration and then revert to the normal program.

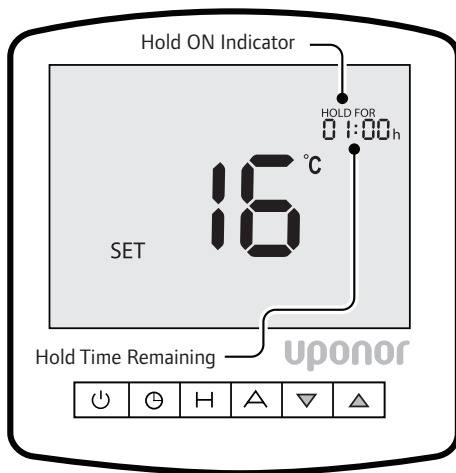

To cancel temperature hold, follow the same steps but reduce the hold time to 00:00.

5.9 Holiday Mode

The holiday function reduces the set temperature in your home to the frost protection temperature setting. For more information, see section "5.10 Frost Protection" on page 12.

The thermostat will maintain this temperature for the duration of the holiday and will then automatically return to the programmed schedule on your return.

To adjust the holiday mode settings, follow these steps:

1. Press **H** three times (until you see the suitcase on screen).
2. Use $\nabla\Delta$ to enter the number of days holiday.
3. Press **A** to confirm settings and return to main display.

The display will show a suitcase indicating the thermostat is in holiday mode.

Note: A holiday period does not start until 00:00 the next day. For example, if you set a holiday period on Friday for 2 days, Saturday will be counted as the first day and the thermostat will revert back to the programmed schedule at 00:00 on Monday.

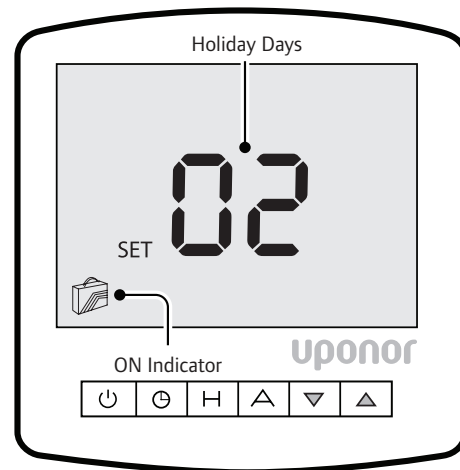

To cancel, follow the same steps but reduce the Holiday duration to 00 days.

5.10 Frost Protection

To activate frost protection mode, follow this step:

1. Press  once.

To cancel frost protection mode, press  once again.

In frost protection mode, the thermostat will display the frost icon and will only turn the heating if the room temperature drops below the set frost temperature.

Use $\nabla\Delta$, while in Frost Protection mode and on the main screen, to change the frost protection temperature.

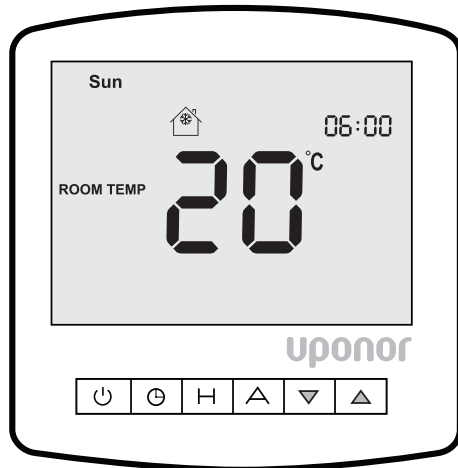

If the heating turns on whilst in frost protection mode, the flame icon will be displayed.



5.11 Optional Features

Most of the following settings are optional. In most cases they do NOT need to be adjusted.



Feature 06 and 07 is required for underfloor heating.

ADJUST OPTIONAL FEATURES

To adjust the optional settings, follow these steps.

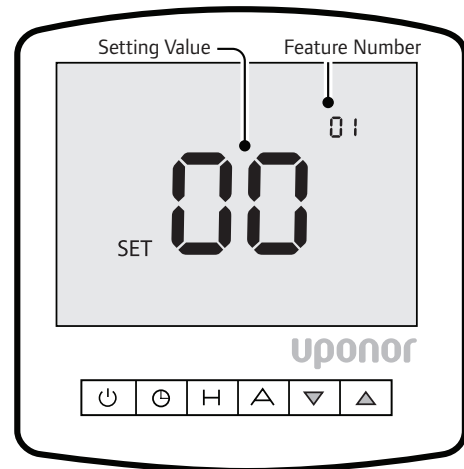
1. If applicable, press and hold  to turn OFF the thermostat.
2. Press and hold  until the display appears as shown below.



3. Use  to cycle through the feature.
4. Use $\nabla\Delta$ to change the setting.
5. Press **A** to confirm settings.
6. Press  once again to turn the thermostat back ON.

OPTIONAL FEATURES OVERVIEW

Feature	Description	Setting
01	Temperature Format	00 = °C 01 = °F (°C default)
02	Switching Differential	01-03 °C (01 °C default)
03	Frost Protection	00 = Enabled (default) 01 = Disabled
04	Output Delay	00-15 Minutes (00 default)
05	Temperature Up/Down Limit	00-10 °C (00 °C default)
06	Sensor Selection	00 = Built In Air Sensor (default) 01 = Remote Air Sensor 02 = Floor Sensor Only 03 = Floor Sensor and Built In Air Sensor 04 = Floor Sensor and Remote Air Sensor
07	Floor Temperature Limit	20-45 °C (27 °C default)
08	Optimum Start	00-03 Hours (00 hours default)
09	Rate of Change	Minutes to raise by 1 °C
10	Programming Mode	00 = 5/2 Day Programming 01 = 7 Day Programming 02 = 24 h Programming
11	Thermostat Mode	00 = Manual 01 = Programmable (01 default)

OPTIONAL FEATURES EXPLAINED

Feature 01 – Temperature Format: This function allows you to select between °C and °F.

Feature 02 – Switching Differential: This function allows you to increase the switching differential of the thermostat. The default is 1°C which means that with a set temperature of 20°C, the thermostat will switch the heating on at 19°C and off at 20°C. With a 2°C differential, the heating will switch on at 18°C and off at 20°C.

Feature 03 – Frost Protection: You can set whether the thermostat will maintain the frost temperature when the thermostat display is turned off. As a default, this is enabled. Frost Protection Temperature is changed by using the $\nabla\Delta$ buttons, while in Frost Protection mode and on the main screen. This is the temperature maintained when the thermostat is in frost protection mode. The range is 07 - 17°C. The default is 12°C and is suitable for most applications.

Feature 04 – Output Delay: To prevent rapid switching, an output delay can be entered. This can be set from 00 - 15 minutes. The default is 00 which means there is no delay.

Feature 05 – Temperature Up/Down Limit: This function allows you to limit the use of the Up and Down keys. This limit is also applicable when the thermostat is locked and so allows you to give others limited control over the heating system.

Feature 06 – Sensor Selection: On this thermostat, you can select which sensor should be used. You can select between air temperature only, floor temperature, or both. When you enable both sensors, the floor sensor is used as a floor limiting sensor and is designed to prevent the floor from overheating.

Note: Built in air sensor only MUST NOT be used to control electric underfloor heating. Floor sensor only or built in air & floor sensor together must be used.

Feature 07 – Floor Temperature Limit: When the Floor Sensor has been enabled in feature 08, you can set a floor limiting temperature between 20-45°C. This protects the floor from overheating.

(27°C is the default).

Feature 08 – Optimum Start: Optimum start will delay the start up of the heating system to the latest possible moment to avoid unnecessary heating and ensure the building is warm at the programmed time. The thermostat uses the rate of change information to calculate how long the heating needs to raise the building temperature 1°C (with a rate of change of 20, the thermostat has calculated the heating needs 20 minutes to raise the building temperature 1°C) and starts the heating accordingly. On this thermostat, optimum start works on the Wake and Return comfort levels.

Feature 09 – Rate of Change: Number of minutes to raise the temperature by 1°C.

Feature 10 – Programming Mode: The following programming modes are available:

- 5/2 Day Programming – 4 levels for the weekdays and 4 different levels for the weekend.
- 7 Day Programming – 4 levels for each day.
- 24h Programming – 4 comfort levels for 24 hours.

Feature 11 – Thermostat Mode: The following thermostat modes are available:

- Manual – Basic up/down override temperature control.
- Programmable – Schedule 4 levels of comfort.

6 Troubleshooting



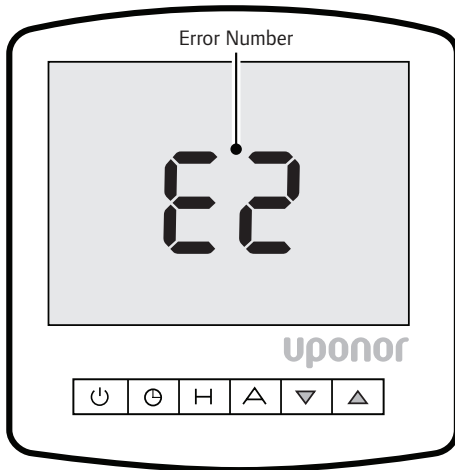



6.1 Error Codes



Error Code	Description
E0	The internal sensor has developed a fault. You should contact your thermostat retailer for assistance.
E1	The remote floor probe has not been connected, has been wired incorrectly or the probe is faulty.
E2	The remote air probe has not been connected, has been wired incorrectly or the probe is faulty.

6.2 Re-calibrate the Thermostat

If you need to re-calibrate the thermostat, follow these steps.

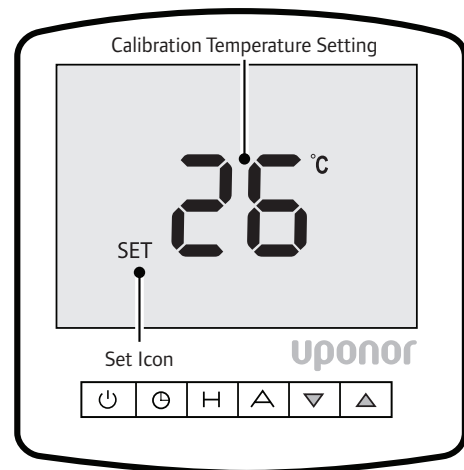

1. Press and hold  to turn the thermostat OFF.
2. Press and hold BOTH  and  together until the temperature appears on the screen.
3. Use  to configure the new temperature.
4. Press  to confirm setting.
5. Press  once to turn the thermostat back ON.



6.3 Factory Reset

The thermostat has a reset function to restore all settings to their factory defaults.

To perform a factory reset, follow these steps.

1. Press and hold  to turn the thermostat OFF.
2. Press and hold  and  together until the LCD powers up.

All of the icons will be displayed on screen. When the icons have disappeared from the screen, the thermostat has been successfully reset.

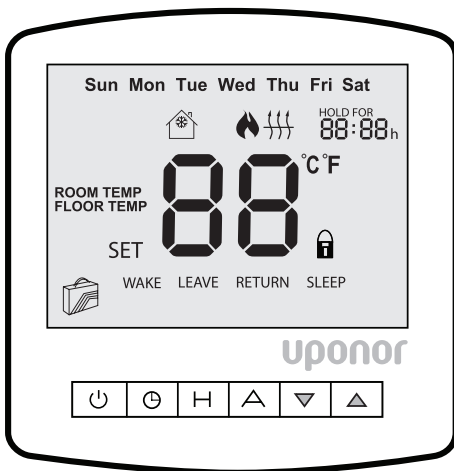

3. Press  once to turn the thermostat back ON.

7 Technical data

7.1 Technical specification

Thermostat	
Model	Uponor Comfort-E Thermostat Dig. Prog Set T-86
Input	230 VAC, 50/60 Hz
Output	230 VAC 230 VAC 16A MAX
IP Rating	IP20



7.2 Dimensions

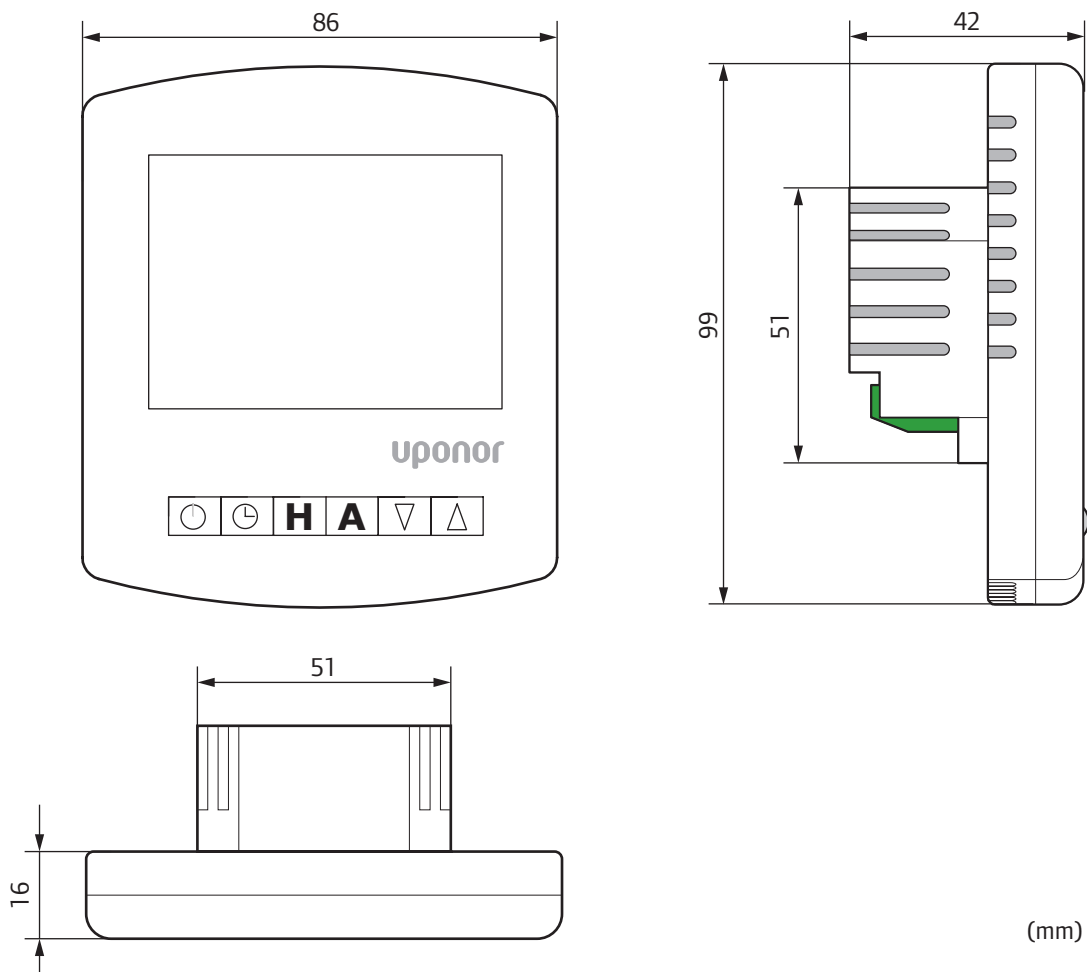

7.3 Wiring Diagram

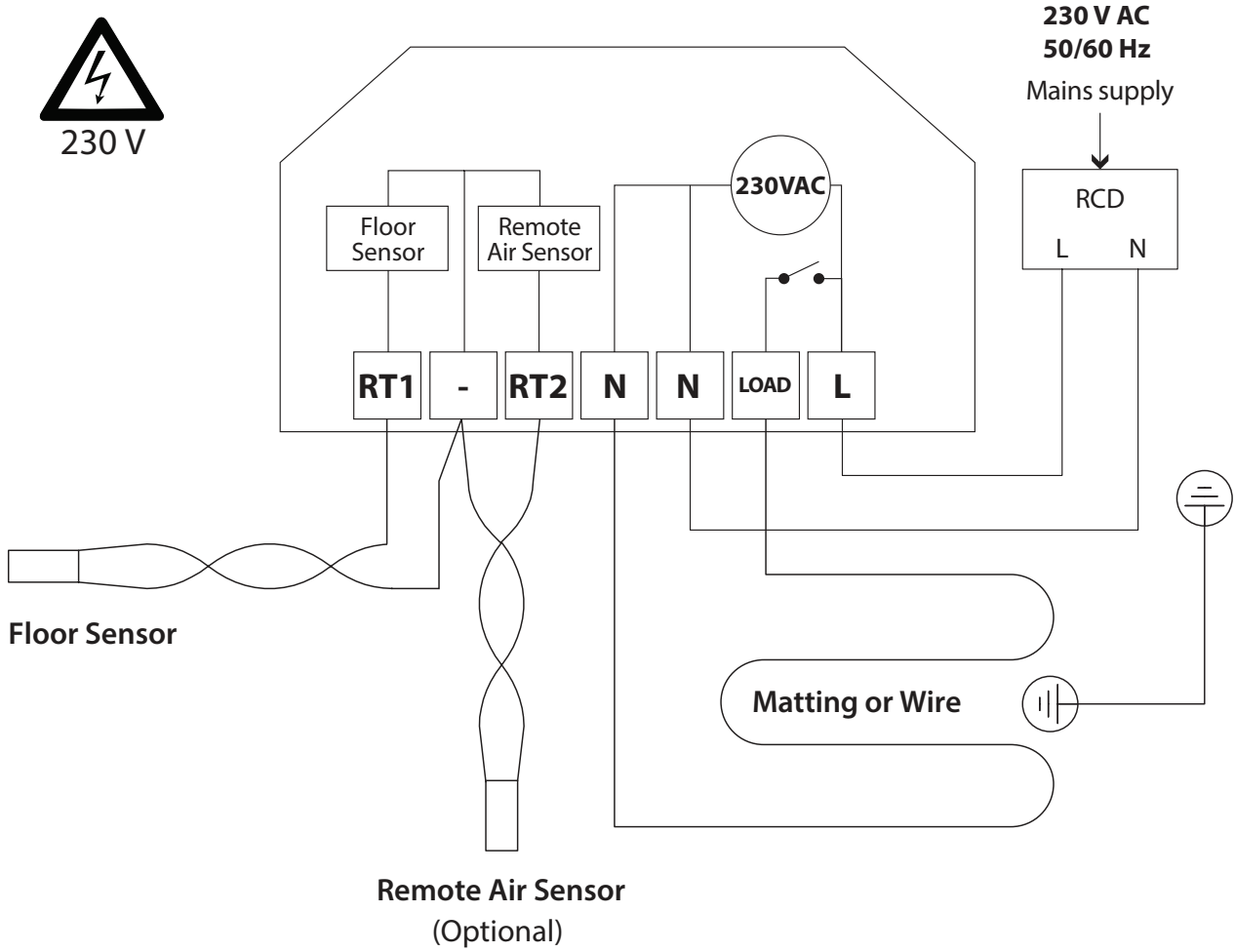



A large area of the page containing numerous horizontal dotted lines, intended for handwritten notes or instructions.



Uponor Corporation
www.uponor.com

Uponor reserves the right to make changes, without prior notification, to the specification of incorporated components in line with its policy of continuous improvement and development.

Uponor